

# Industrial Cutting Tool Storage CNC Transport & Storage



Get Organized



Buying Guide

## ToolScoot Tree

- Shelf slots provide 35 locations per side (70 total).
- Heavy 14 gauge unibody construction with see through design.
- Includes 6 shelves - 5 for toolholders and 1 utility.
- Nylon inserts protect and securely hold toolholders.
- Every 5th slot marked for easy shelf positioning.
- Shelves can be set flat or at a 20 degree angle.
- 16 gauge steel shelves for strength and rugged durability.
- Casters are load rated to 1,200 pounds.
- Heavy duty 5" casters - two swivel with brakes and two stationary.



Wall Mount Tree

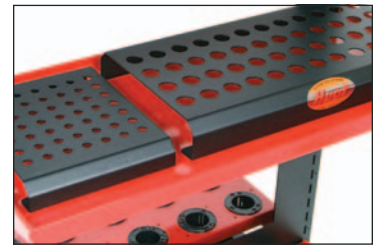

Each unit comes standard with a shelf that will hold a variety of our collet racks

EDP#	ToolScoot Trees 28.5" wide x 57" tall x 28" deep	Weight
55930	Holds 90 BT, CAT "V" flange, NMTB 30 taper toolholders	160 lbs.
55940	Holds 90 BT, CAT "V" flange, NMTB 40 taper toolholders	160 lbs.
55950	Holds 50 BT, CAT "V" flange, NMTB 50 taper toolholders	160 lbs.
55970	Holds 90 HSK 63A toolholders	160 lbs.
55976	Holds 90 HSK 63F toolholders	160 lbs.
55980	Holds 50 HSK 100A toolholders	160 lbs.
	<b>ToolScoot Wall Mount Trees 28.5" wide x 36" tall x 14" deep</b>	
55740	Holds 54 BT, CAT "V" flange, NMTB 40 taper toolholders	55 lbs.
55750	Holds 30 BT, CAT "V" flange, NMTB 50 taper toolholders	55 lbs.
55770	Holds 54 HSK 63A toolholders	55 lbs.
55780	Holds 30 HSK 100A toolholders	55 lbs.
	<b>ToolScoot Tree and Wall Mount Tree Accessories</b>	
55100	Toolbox with Writing Surface and Built-in Storage	
55110	Utility Shelf	
55111	Maple Butcher Block Shelf Insert	
55112	Dark Precision Stone Block Shelf Insert	
55113	Light Precision Stone Block Shelf Insert	
55140	40 Taper Extra Shelf	
55170	HSK 63A Extra Shelf	
55150	50 Taper Extra Shelf	
55180	HSK 100A Extra Shelf	



Built-in pegboard holes for hanging just about anything



Built-in slots provide easy and convenient storage for your spanner wrenches

## ToolScoot™/Tool Cart for CNC V-Flange, HSK and CAPTO\*

Quality and mobility at an affordable price. Durable nylon inserts on both shelves help protect tool holders. Lower shelf angled for quick, easy tool access from either side. Solid, interlocking side panel construction for maximum strength and stability.



EDP #13940

Two end storage trays with universal mounting holes for tool lock. Heavy duty 5" x 1 1/4" casters load rated at 1000 lbs. All steel painted with our durable Ecolo-Clad in red and black.

**EDP #13930** Holds 48 BT, CAT "V" Flange, NMTB For 30 taper

**EDP #13935** Holds 48 BT For 35 taper

**EDP #13940** Holds 48 BT, CAT "V" Flange, NMTB For 40 taper

**EDP #13945** Holds 36 BT, CAT "V" Flange For 45 taper

**EDP #13950** Holds 36 BT, CAT "V" Flange, NMTB For 50 taper

**EDP #13955** Holds 100 16C collets

**EDP #13958** Holds 36 20C collets

**EDP #13960** Holds 96 5C collets

**EDP #13965** Holds 96, R8 or #4 Morse Taper

**EDP #13970** Holds 48 HSK 63A toolholders

**EDP #13980** Holds 36 HSK 100A toolholders

**EDP #13984** (C4 CAPTO style) ToolScoot

**EDP #13985** (C5 CAPTO style) ToolScoot

**EDP #13986** (C6 CAPTO style) ToolScoot

**EDP #13988** (C8 CAPTO style) ToolScoot

**Dimensions:** 18"W x 35 1/4"L x 35"H.

**Weight:** 75 lbs.



## ToolTower for NC V-Flange, HSK, VDI & CAPTO\*

The Huot NC ToolTower provides an economical, free standing storage unit for 30, 40 and 50 taper toolholders and HSK 63A, and 100A. The ToolTower comes with 3 shelves and with optional stacking kit can be stacked to form a 5 or 6 shelf tower, providing a cost effective way to store and protect many NC toolholders in a compact space.

- Individual units are 3' tall. Optional stacking kit #14860 is sold separately.
- Nylon inserts protect each tool holder.
- Sturdy 16 gauge steel construction.
- Optional tool lock tray can be mounted on either side panel, possible spacing change.
- ToolTower should be bolted to the floor for additional security.
- UPS shippable.

**EDP #13830** Holds 30 taper, 3 shelves-24 ea.

**EDP #13835** Holds 35 taper, 3 shelves-24 ea.

**EDP #13840** Holds 40 taper, 3 shelves-24 ea.

**EDP #13845** Holds 45 taper, 3 shelves-18 ea.

**EDP #13850** Holds 50 taper, 3 shelves-18 ea.

**EDP #13858** Holds 72 20C collets

**EDP #13860** Holds 5C collets, 3 shelves-50 ea.

**EDP #13865** Holds R8 or #4 Morse Taper tools, 3 shelves-50 ea.



EDP #13850 - two stacked

**EDP #13870** Holds HSK 63A, 3 shelves-24 ea.

**EDP #13880** Holds HSK 100A, 3 shelves-18 ea.

**EDP #13884** (C4 CAPTO style) ToolTower

**EDP #13885** (C5 CAPTO style) ToolTower

**EDP #13886** (C6 CAPTO style) ToolTower

**EDP #13888** (C8 CAPTO style) ToolTower

**EDP #13890** Holds 16C collets, 3 shelves-50 ea.

**EDP #13893** Holds #30 VDI, 3 shelves-24 ea.

**EDP #13894** Holds #40 VDI, 3 shelves-24 ea.

**Dimensions:** 27 5/16" W x 18 5/16" D x 36" H.

**Weight:** 65lbs.

**EDP #14860** Optional accessory stacking kit.

**EDP #14865** Optional accessory tool lock tray.

\*CAPTO Registered Trademark Sandvik Corp.

## Toolholder Vises

Models 50525, 50526, 50527 & 50528 are heavy duty and designed to be bolted directly to our ToolScoot side shelves, work bench or any place heavy tool changing is performed. These unique products provide a convenient point-of-use venue for easy loading of cutting tools or pull studs.

**EDP #50525** For 40 CAT-V    **EDP #50526** For 40 BT

**EDP #50527** For 50CAT-V    **EDP #50528** For 50 BT



**NEW!**

## ToolScoot & ToolTower Drawer

This great new Toolbox is designed to mount securely in the space already available at the bottom of your Huot ToolScoot. With inside dimensions of 23-5/8" x 17" x 4" the lockable drawer provides ample space for most any tool, manual, CD's, lunchbox, billfold or whatever you want to keep handy within your work space. The drawer glides easily on full extension HD ball bearing slides and the full sized lid with built in cam-lock keeps everything clean and secure. Huot Toolbox Drawer easily mounts in your ToolScoot in just minutes with holes already existing on your cart. It can also be mounted on a Huot ToolTower by simply drilling a few 1/4" holes.

**EDP #14900**

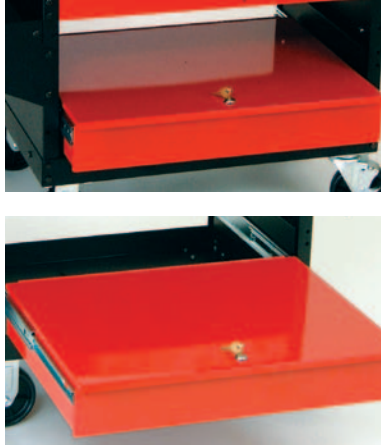

**NEW!**



## Doors for ToolScoot & ToolTower

Our doors are built from heavy 16 gauge steel for strength with a durable polycarbonate window for visibility. A large barrel piano style hinge makes installation a snap. They provide security as well as protect your valuable toolholders from flying chips and other airborne contaminants. Each door has a built in cam-style lock that mates with the other door providing a positive connection at both the top and bottom. The polycarbonate window offers protection yet allows the user to locate the proper tool at a glance. Order one set of doors per side.

**EDP #50515** One set of doors for traditional 2-shelf ToolScoot

**EDP #50520** One set of doors for 3-shelf TriScoot on page 6 or ToolTower on page 2



**NEW!**

## CNC Tooling Safety Covers

**EDP #14000** For use on Huot ToolScoots with 30, 35, 40 or HSK63A tapers

**EDP #14001** 100% clear for use on Huot ToolScoots with 30, 35, 40 or HSK63A tapers

**EDP #14015** For use on Huot ToolScoots with 45, 50 or HSK100A tapers

**EDP #14016** 100% clear for use on Huot ToolScoots with 45, 50 or HSK100A tapers

- Keeps tools from getting nicked and marred.
- Protects your investment in expensive tooling.
- Write on top with a dry erase marker for faster set-ups.
- Keeps staged tooling clean and ready to go.
- Covers are held in place with key-hole slots molded into the base.
- Far cheaper than stitches and helps keep everyone safe, productive and working.
- Helps protect operator from accidental injuries on sharp tooling.

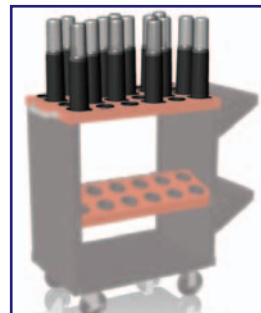

- Semi-transparent top reduces industrial espionage while allowing the operator to see the tooling.

**Dimensions:** 14" H.    **Weight:** 1/2 pound each.

## CNC V-Flange and HSK SuperScoot™

Constructed of prime 12 gauge steel for rugged heavy duty use. Almost twice the storage capacity for less!

Heavier duty than others in its class.

### EDP #23930

for 30 taper, 45 per shelf, 90 total

### EDP #23940

for 40 taper, 45 per shelf, 90 total

### EDP #23950

for 50 taper, 26 per shelf, 52 total

### EDP #23960

for 60 taper, 6 per shelf, 12 total

### EDP #23125

for HSK125A, 6 per shelf, 12 total

### EDP #23970 HSK

for 63A European style taper, 45 per shelf, 90 total

### EDP #23980 HSK

for 100A European style taper, 26 per shelf, 52 total



**New outrigger base design for improved stability, easier maneuverability for a safe, smooth tool ride.**

### Dimensions of SuperScoot:

45-1/4" W x 17-1/2" D x 40" H  
(width includes handle & end tray)

### Shipping weight: 132 lbs.

Heavy duty, extra smooth rolling casters load rated to 1600 lbs. for long caster life, with locking caster mechanism.

Finished in beautiful gold vein powder coating, baked on for lasting durability.

Phosphate pretreatment undercoating for additional toughness.

Designed for maximum toolholder capacity per square foot of cart space.



## SuperTower

### Dimensions of SuperTower:

33-3/4" W x 17-1/2" D x 33 1/2" H

### Shipping Weight: 95 lbs.

### EDP #23840

for 40 taper, 45 holes per shelf, 135 total capacity

### EDP #23850

for 50 taper, 26 holes per shelf, 78 total capacity

### EDP #23870

for HSK 63A European style tooling, 45 per shelf, 135 total capacity

### EDP #23880

for HSK 100A European style tooling, 26 per shelf, 78 total capacity

Additional shelves available.

Constructed of prime 12 gauge steel for rugged heavy duty use.

Finished in beautiful, strong gold vein powder coating, baked on for lasting durability.

Phosphate pretreatment undercoating for additional toughness.

Angled shelving for easier, quicker tool access.



**SuperTower can be stored inside a standard 36" x 18" wide cabinet.**

Almost twice the storage capacity for less! Heavier duty than others in its class.

For added safety ToolTower should be bolted to the floor.

### EDP #24860

Two SuperTowers may be stacked together using this stacking kit.

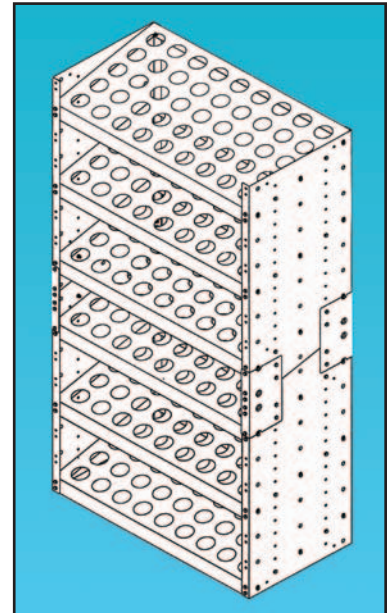

**Tower is stackable two high to expand your storage area.**

## TriScoot

The world famous Huot ToolScoot is now available with 3 shelves for even more storage space in the same footprint. This cart is ruggedly built just like the original but with a third more capacity and standing almost 7" taller.

**EDP #13409** Holds 72 BT, CAT "V" Flange, NMTB For 40 taper.

**EDP #13509** Holds 54 BT, CAT "V" Flange, NMTB For 50 taper.

**EDP #13916** Holds 54 3J Collets.

**EDP #13963** Holds 72 KM63 Toolholders.

**EDP #13993** Cart for #30 VDI. Holds 72 toolholders.

**EDP #13994** Cart for #40 VDI. Holds 72 toolholders.

**EDP #14865** Side Tray is a handy way to store collets, wrenches, wiping cloths and the like.



**EDP #13993**  
**Mobile Transport**

## Machine or Wall Mount CNC ToolHolder Racks



**EDP #14776**

**EDP #14763**

Holds seven KM63 toolholders.

**EDP #14771**

Holds seven 40 taper V-flange CNC toolholders.

**EDP #14776**

Holds five 50 taper V-flange CNC toolholders.

**EDP #14781**

Holds seven HSK 63A CNC toolholders.

**EDP #14791**

Holds five HSK 100A CNC toolholders.

Mounts directly on the CNC machine or on a wall in any convenient location.

## CNC, V-Flange, CAPTO, VDI, HSK ToolHolders & Collet Platform

Conveniently holds your CNC toolholders or collets, at the ready, for quick access. Angled platform for 30-35-40-45-50, HSK63A-HSK100A taper tools and 5C or R8 collets. Holds 24 toolholders for 30-35 and 40 taper, 18 tools for 45 and 50 taper, and 50 tools for 5C or R8 or 50 #4 morse taper.

**Dimensions:** 27¼" W x 20¼" D x 11" H. at rear of rack.

**Weight:** 15 lbs.

**EDP #14858**

Holds 24 20C collets

**EDP #14863**

Holds 24 KM63 ToolHolders

**EDP #14880**

For HSK63A. Holds (24) taper tools

**EDP #14885**

For HSK100A. Holds (18) taper tools

**Model 30P EDP #14830**

Holds (24) 30 taper tools

**Model 35P EDP #14835**

Holds (24) 35 taper tools



**EDP #14840**

**Model 40P EDP #14840**

Holds (24) 40 taper tools

**Model 45P EDP #14845**

Holds (18) 45 taper tools

**Model 50P EDP #14850**

Holds (18) 50 taper tools

**Model 96P5C EDP #14856**

Holds (48) 5C collets

**Model 96P16C EDP #14857**

Holds (50) 16C collets

**Model 96PR8 EDP #14866**

Holds (50) R8 or #4 morse taper

**EDP #14824 (C4 style) Bench top Platform**

**EDP #14825 (C5 style) Bench top Platform**

**EDP #14826 (C6 style) Bench top Platform**

Conveniently holds your CAPTO toolholders at the ready for quick access. Angled platform for C4, C5 or C6 toolholders.

- Holds 24 CAPTO style toolholders.

**Dimensions:** 27¼" W x 20¼" D x 11" H at rear of rack.

**Weight:** 15 pounds.

**EDP #14833 Bench Top Platform For #30 VDI**

**EDP #14834 Bench Top Platform For #40 VDI**

**Dimensions:** 27¼" W x 20¼" D x 11" H at rear of rack.

**Weight:** 15 pounds.

## V-Flange & HSK Tooling Transport for Narrow Spaces

Only 15" wide, SpeedyScoot™ lets you easily move tooling through narrow spaces between machines and around tight corners. Built heavy duty for the factory floor, SpeedyScoot combines rugged quality and easy mobility at an affordable price. Durable nylon inserts help protect tool holders. Solid side panel construction for maximum strength, stability and cleanliness. Standard features:

- Durable nylon inserts to help prevent tooling damage.
- Heavy duty 4" x 1-1/2" casters load rated at 1000 lbs.
- All steel infrared-baked epoxy finish in textured black with phosphate pretreatment.
- Plus options to suit your production needs including middle shelves and drawers.



**EDP #33940** BT, CAT "V" Flange, NMTB For 40 taper, holds 24 tools\*, 52 lbs.

**EDP #33950** BT, CAT "V" Flange, NMTB For 50 taper, holds 15 tools\*, 52 lbs.

**EDP #33970** HSK 63A, holds 24 tools\*, 52 lbs.

**EDP #33980** HSK 100A, holds 15 tools\*, 52 lbs.

Dimensions: 15" W x 30" Long x 35" H.

Weight: 52 lbs. Can be shipped U.P.S.

\*Tooling Capacity: Double capacity with optional second shelf (see below).



## SpeedyScoot™ Options

### Tool Drawer

Tool drawer with ball bearing slides and built in cam lock, 14 lbs.

**EDP #30001** (Note: Requires EDP #14190 2nd shelf without holes for mounting drawer.)

### 2nd Flat Shelf Storage

2nd shelf without holes for bulk storage, 6 lbs. **EDP #14190**

### 2nd Shelf Tooling Storage

2nd shelf for 40 taper, 6 lbs. **EDP #14170**

2nd shelf for 50 taper, 6 lbs. **EDP #14175**

2nd shelf for HSK 63A, 6 lbs. **EDP #14180**

2nd shelf for HSK 100A, 6 lbs. **EDP #14185**

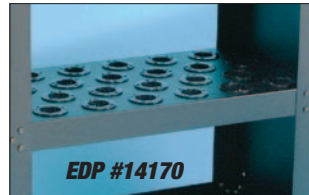

## Custom Scoot

Although we can build carts for almost twenty different toolholder sizes ranging from the common BT, CAT and HSK sizes to the most obscure, we don't cover them all. With that in mind and knowing someone out there still needs our help, we've devised a cart just for them. This customizable product consists of a 3 shelf TriScoot with a 3/8" thick polycarbonate sheet secured to each metal shelf. All you need to do is provide us with the dimension at the top of the longest plane (shown as D1 on the diagram shown here) on your toolholder and we'll mill the holes in the polycarbonate to fit your need.

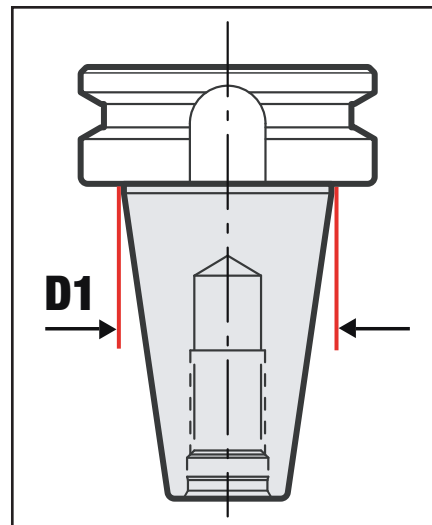

## Multi-Purpose Displays

Securely display screwdriver bits, nutsetters, drill bits, saw blades and more. Steel construction, in either red or textured black, with locking clear poly cover. Small display is 11" wide x 18.5" deep and large display is 18.5" wide x 18.5" deep. Small display has three channels and the large display has five channels. Each channel is 3.75" x 18" and can be subdivided every inch with the provided movable dividers. Each subdivider has an angled top for placement of a bar code, price tag or other label.

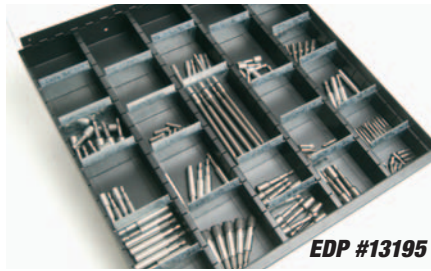

- EDP #13192** 3-row black
- EDP #13193** 3-row red
- EDP #13194** 5-row red
- EDP #13195** 5-row black



**EDP #13193**

## Drill Dispensers, Master

### EDP #13175 U.S. SIZES

Holds full packages (minimum of 12 pcs.) of jobber or screw machine length drills, fractional, letter and wire gauge sizes in one complete cabinet.

- Top drawer holds fractional drills  $\frac{1}{16}$ " to  $\frac{1}{2}$ " by 64th with 42 compartments.
- 2nd drawer is for #1 to #60 wire gauge with 75 compartments.
- 3rd drawer for letter size A to Z with 42 compartments.
- Drawer Divider Kits available for lower drawer. (See page 22 #14030 & #14060)

### EDP #13085

Holds metric drill bits from 1 mm to 25 mm x 0.5 mm.

### EDP #13180

Holds metric drills from .35mm to 13.00mm. Sizes include: .35mm to 2.50mm by .05mm, 2.6mm to 10.0mm by .1mm, 10.2mm, 10.5mm, 10.8mm, 11.0mm, 11.2mm, 11.5mm, 11.8mm, 12.0mm, 12.2mm, 12.5mm, and 13.0mm.

138 compartments to store and inventory all your metric drill bits. Same great features as our #13175 jobbers length master cabinet.

**Dimensions:** 26" W x 12" D x 12½" H.

**Weight:** 50 lbs.



**EDP #13175**

### U.S. & Metric Master Drill Dispensers Feature:

- Ball bearing drawer slides
- All steel cabinet with vinyl dividers to help protect and separate bits.
- Each cabinet is lockable and comes with set of two keys.
- Each drawer measures 23½" wide; 11" front to back.
- Stackable for larger inventories at one location.
- Lower drawer is undivided for extra long drills, reamers and miscellaneous tools.
- Built in cam lock with two keys.

## Point of Purchase Drill and Tap Displays



**EDP #13125**

### Model 6 EDP #13125

For fractional drills  $\frac{1}{16}$ " to  $\frac{1}{2}$ " by 64ths. Powder coated red.

### EDP #13132

For fractional drills  $\frac{1}{16}$ " to  $\frac{1}{2}$ " by 64ths. Powder coated royal blue.

### Model 7 EDP #13126

For wire gauge drills #1 to #60. Powder coated red.

### Model 8 EDP #13127

For letter drills A to Z. Powder coated red.

### EDP #13140

For taps and dies. Holds these sizes:

- $\frac{1}{8}$ -27 NPT, 4-40 NC, 6-32 NC, 8-32 NC
- 10-24 NC, 10-32 NF, 12-24 NC,  $\frac{1}{4}$ -20 NC
- $\frac{1}{4}$ -28 NF,  $\frac{5}{16}$ -18 NC,  $\frac{5}{16}$ -24 NF,  $\frac{3}{8}$ -16 NC

- $\frac{3}{8}$ -24 NF,  $\frac{7}{16}$ -14 NC,  $\frac{7}{16}$ -20 NF,  $\frac{1}{2}$ -13 NC
- $\frac{1}{2}$ -20 NF,  $\frac{9}{16}$ -12 NC,  $\frac{9}{16}$ -18 NF,  $\frac{5}{8}$ -11 NC
- $\frac{5}{8}$ -18 NF,  $\frac{3}{4}$ -10 NC,  $\frac{3}{4}$ -16 NF,
- T-Handle Wrench 0 to ¼"

- All steel welded outer shell with clear, hinged polycarbonate front for high visibility and shatterproof durability. Lockable with own set of two keys.
- Steel drill gauge on top assures correct sizing of drills.
- All compartments are rounded to make small drills readily accessible.
- Compact display makes excellent use of counter space for impulse sales.

**Dimensions:** 12¾" W x 14" D x 14¼" H.

**Weight:** 14 lbs.



## Drill Dispensers, Jobbers & Stub/Screw Machine Dispensers, Original

**Model 1 EDP #13000** Holds fractional drills  $\frac{1}{16}$ " to  $\frac{1}{2}$ " by 64ths. Wt. 10 $\frac{1}{4}$  lbs.

**Model 2 EDP #13025** Holds drills #1 to #60 Wire Gauge. Wt. 13 $\frac{1}{4}$  lbs.

**Model 3 EDP #13050** Holds drills A to Z letter size. Wt. 10 $\frac{1}{4}$  lbs.

**Model 4 EDP #13075** Holds drills 1mm to 13mm by 0.5mm. Wt. 10 $\frac{1}{4}$  lbs.

**Model 5 EDP #13100** Holds drills 1mm to 6.9mm by 0.1mm. Wt. 13 $\frac{3}{4}$  lbs.

**Model 84 EDP #13040** Holds drills #1 to #80 Wire Gauge Wt. 13 $\frac{3}{4}$  lbs.

**Dimensions:** 14 $\frac{5}{8}$ " W x 7 $\frac{3}{8}$ " D x 7 $\frac{3}{4}$ " H.

**Most Drill Dispensers (Jobber and Stub/Screw) feature:**

- Holds full packages of each size (12 pc. min.).
- Stackable for larger inventories.
- One piece drawer slide for long useful life.
- Decimal equivalents.



EDP #13000



EDP #13025



EDP #13050

**Model 1SM EDP #13015** Stub drills  $\frac{1}{16}$ " to  $\frac{1}{2}$ " x 64ths, 10 $\frac{1}{4}$  lbs. ea.

**Model 2SM EDP #13030** Stub drills 1-60, 13 $\frac{1}{4}$  lbs. ea.

**Model 3SM EDP #13060** Stub drills A-Z, 10 $\frac{1}{4}$  lbs. ea.

**Model 4SM EDP #13080** Stub drills 1mm-13mm x 0.5mm, 10 $\frac{1}{4}$  lbs. ea.

**Model 5SM EDP #13090** Stub drills 1mm-6.9mm x 0.1mm, 13 $\frac{3}{4}$  lbs. ea.

**Dimensions:** 14 $\frac{5}{8}$ " W x 7 $\frac{3}{8}$ " D x 7 $\frac{3}{4}$ " H.

Same features as original dispensers but marked for screw machine length to help control inventory.

See #14100 on page 22 for securely locking up to 3 original series dispensers.

## Fractional, Letter, Wire, Metric All-In-One, Master

### EDP #13190

#### Drills, Fractional, Letter, Wire, Metric, All-In-One

Cabinet holds fractional drills  $\frac{1}{16}$ " to  $\frac{1}{2}$ " by 64ths, 1 to 60 wire gauge, A to Z letter sizes and metric from 0.35mm to 13.00mm including 0.35mm to 2.50mm x .05mm, 2.6mm to 10.0mm x .1mm, and 10.2, 10.5, 10.8, 11.0, 11.2, 11.5, 11.8, 12.0, 12.2, 12.5, 13.0mm. Will hold a minimum of full packages of each size. Weight 80 lbs.

### EDP #13700

#### Metric Drills, End Mills, Reamers, All-In-One

**Metric** 4 in 1 Combination Dispenser

**Drills** - Metric .35mm to 2.5mm x .05mm, 2.6mm to 10mm x .1 and additional common sizes up to 13mm.

**End Mills** - Metric 2.0 to 7.0 x .5 and 8.0, 9.0, 10.0, 11.0, 12.0, 12.5, 13.0mm

**Taps** - 31 of most commonly used taps from 2.5mm x .45 to 30mm x 3.50mm

**Reamers** - Metric 1.0mm to 13.0mm x .5

Both models are 6 drawer cabinets measuring 26" W by 12" D by 15 $\frac{3}{8}$ " H and ship at 80 lbs. Must ship via LTL, not via UPS. Drawers measure 23 $\frac{1}{8}$ " W x 11" D x 2" H. Equipped with smooth ball bearing drawer slides. Weight 80 lbs.



EDP #13190

## Taper Shank/Taper Length Drill Dispenser, Master

### Model 57 EDP #13185

- Conveniently stores Taper Length or Taper Shank Drills from 1/8" to 1" by 64ths.
- Vinyl drawer dividers separate and protect drills.
- Drawer dimensions: 23 7/8" L x 11" W (front to back).
- Stackable with other dispensers.
- Built-in cam lock with two keys.
- Equipped with smooth ball bearing drawer slides.

**Dimensions:** Measures 26" W x 12" D x 12 1/2" H.

**Weight:** 50 lbs.



**EDP #13185**

## Silver Deming, Master

### Model/EDP #13165

Cabinet holds the following Silver Deming drills, 3/64ths to 1" by 64ths, as well as 1-1/32", 1-1/16", 1-1/8", 1-3/16", 1-1/4", 1-3/8", 1-1/2".

The lockable dispenser contains a total of 110 compartments, 103 identified for each size Silver Deming drill, and an additional 7 compartments for specialized requirements.

Equipped with smooth ball bearing drawer slides.

6 drawer cabinet measuring 26" W by 12" D by 15 13/16" H.  
Drawers measure 23 7/8" W x 11" D x 2" H.

**Weight:** 80 lbs.

Must ship via LTL, not via UPS.



**EDP #13165**

## Silver Deming, Original

### EDP #13166

Holds 2 each reduced shank S/D bits from 33/64ths to 63/64ths by 64ths

**Dimensions:** 14-5/8" W x 7-3/8" D x 7-3/4" H.

**Weight:** 13-1/4 lbs.

### EDP #13167

Holds 2 each reduced shank S/D bits 1", 1-1/32", 1-1/16", 1-1/8", 1-5/32", 1-3/16", 1-1/4", 1-5/16", 1-3/8", 1-7/16", 1-1/2"

**Dimensions:** 14-5/8" W x 7-3/8" D x 7-3/4" H.

**Weight:** 10-3/4 lbs.

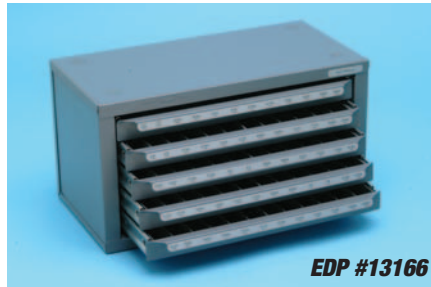

**EDP #13166**



**EDP #13167**

## Carbide Burr Dispenser, Original

### EDP #13200

Holds these sizes: Cylindrical 1/4" x 5/8", Cyl. Rad. End 1/4" x 5/8", Ball 1/4" x 1/4", Oval 1/4" x 3/8", Tree Rad. 1/4" x 3/4", Tree/Pointed 1/4" x 3/4", Cone/Rad. End 1/4" x 5/8", Cylindrical 3/8" x 3/4", Cyl./Rad. End 3/8" x 3/4", Ball 3/8", Oval 3/8" x 5/8", Tree/Rad. End 3/8" x 3/4", Tree/Pointed 3/8" x 3/4", Cone/Rad. End 3/8" x 1 1/16", Cone/Flat End 1/4" x 1",



Cone/Rad. End 1/2" x 1 1/8", Cone/Flat End 3/8" x 1", Cylindrical 1/2" x 1", Cyl./Rad. End 1/2" x 1", Ball 1/2", Oval 1/2" x 7/8", Tree/Rad. End 1/2" x 1", Tree/Pointed 1/2" x 1", Cone/Flat End 1/2" x 1"

**Dimensions:** 14 5/8" W x 7 3/8" D x 7 3/4" H.

**Weight:** 10 1/2 lbs.

## Tap Dispensers, Master

### EDP #13585

- Holds most common NC/NF sizes from ¼" to ½".
- Holds metrics from 2.5 mm to 30 mm.
- Holds machine screw size 2-56 thru 12-28, taper, plug, bottom and spiral.
- Extruded vinyl drawer dividers protect taps.
- Top drawer has 40 compartments.
- Second drawer has 78 compartments.
- Third drawer has 21 compartments.
- Fourth drawer has 13 compartments.
- Stackable for larger inventories.
- Lockable.
- Ball bearing drawer slides.

**Dimensions:** 26" W x 12" D x 12½" H. **Weight:** 50 lbs.



EDP #13585

### EDP #13580

- For sizes ¼"-20 to 1"-14 taps
  - Holds bottom, plug and taper of each size:
- |       |       |       |       |       |       |         |         |
|-------|-------|-------|-------|-------|-------|---------|---------|
| ¼"-20 | ¼"-28 | ⅝"-18 | ⅝"-24 | ¾"-16 | ¾"-24 | ⅞"-14   | ⅞"-20   |
| ½"-13 | ½"-20 | ⅞"-12 | ⅞"-18 | 1"-11 | 1"-18 | 1 ¼"-10 | 1 ¼"-16 |
| ⅞"-9  | ⅞"-14 | 1"-8  | 1"-14 |       |       |         |         |

- Holds taper, plug, bottom and spiral:

2-56	3-48	3-56	4-40	4-48	5-40	5-44	6-32
6-40	8-32	8-36	10-24	10-32	12-24	12-28	

**Dimensions:** 26" W x 12" D x 12½" H. **Weight:** 50 lbs.

## Tap Dispenser, Original

### EDP #13500

- |         |         |         |         |
|---------|---------|---------|---------|
| ¼"-20NC | ¼"-28NF | ⅝"-18NC | ⅝"-24NF |
| ¾"-16NC | ¾"-24NF | ⅞"-14NC | ⅞"-20NF |
| ½"-13NC | ½"-20NF | ⅞"-12NC | ⅞"-18NF |
| ⅝"-11NC | ⅝"-18NF | ¾"-10NC | ¾"-16NF |
| ⅞"-9NC  | ⅞"-14NF | 1"-8NC  | 1"-14NF |

**Weight:** 10½ lbs.

### EDP #13550

Holds taper, plug, bottoming, and spiral point taps. 60 compartments. Holds machine screw sizes:

2-56	3-48	3-56	4-40	4-48	5-40
5-44	6-32	6-40	8-32	8-36	10-24
10-32	12-24	12-28			



EDP #13550

**Weight:** 13 lbs.

- One piece drawer slide for long, useful life.
- Stackable.

### EDP #13575

Holds 29 popular metric sizes:

3mm x .50	3mm x .60	4mm x .70
4mm x .75	5mm x .80	5mm x .90
6mm x 1.00	6.3mm x 1.00	7mm x 1.00
8mm x 1.00	8mm x 1.25	9mm x .75
9mm x 1.00	9mm x 1.25	10mm x 1.00
10mm x 1.25	10mm x 1.50	11mm x 1.50
12mm x 1.25	12mm x 1.50	12 mm x 1.75
14mm x 1.25	14mm x 1.50	14mm x 2.00
16mm x 1.50	16mm x 2.00	18 mm x 2.50
20mm x 2.50	24mm x 3.00	

**Dimensions:** All models measure 14¾" W x 7¾" D x 7¼" H.

**Weight:** 10½ lbs.

## Tap & Drill Dispensers, Master

### EDP #13597

Holds Tap & Drill sizes #0-80 3/64 to 1.5-12 1-27/64

- Conveniently holds tap with the corresponding tap drill. No wasted time looking for proper sizes as they'll be right at your fingertips.
- Holds approximately one dozen each of the smaller sizes and at least several of each of the larger sizes.
- Built in cam lock with two keys.
- Heavy duty ball-bearing drawer slides for easy use and long service life.

**Dimensions:** 26" L x 12" W x 12½" H. **Weight:** 50 pounds.

### EDP #13599

Same great features as above model but for metric taps and drills. M1.6x0.35 1.25mm to M24x2.0 22.00mm

**Dimensions:** 26" L x 12" W x 12½" H. **Weight:** 50 pounds.



EDP #13597

## National Pipe Tap Dispenser, Original

### EDP #13560

#### Top drawer has 13 compartments

Holds NPT from 1/16" to 2"  
 Two for 1/16" - 27  
 Two for 1/8" - 27  
 Three for 1/4" - 18  
 Three for 3/8" - 18  
 Three for 1/2" - 14

#### Middle drawer has 6 compartments

Three for 3/4" - 14  
 Two for 1" - 11-1/2  
 One oversized for 1-1/4" - 11-1/2



EDP #13560

#### Bottom drawer has 2 oversized compartments

One for 1-1/2" - 11-1/2  
 One for 2" - 11-1/2

**Dimensions:** 14-5/8" W x 7-3/8" D x 7-3/4" H

**Weight:** 10-1/4 lbs.

Phosphate pretreatment and finished in Huot's battleship gray powder coating for good looking inventory control and long useful life.

## Tap and Drill Dispenser, Original

### Model 1414 EDP #13590

TAP	DRILL
6 - 32	#36
8 - 32	#29
10 - 24	#25
10 - 32	#21
1/4 - 20	#7
1/4 - 28	#3
5/16 - 18	F
5/16 - 24	I
3/8 - 16	5/16
3/8 - 24	Q
7/16 - 14	U



EDP #13590

TAP	DRILL
7/16 - 20	25/64
1/2 - 13	27/64
1/2 - 20	29/64

- Stores and organizes correct drill with corresponding size Tap.
- Holds approximately one dozen (minimum) of each size.

**Dimensions:** 14 5/8" W x 7 3/8" D x 7 3/4" H.

**Weight:** 10 1/2 lbs.

## Metric Taps, Drills/Dies, Original

### EDP #13595

Holds Metric taps, drill and dies. From 2.5 x .45 tap to 12.0 x 1.75 tap and holds the following sizes:

#### Top drawer holds:

2.5 x .45 tap - 2.05 drill, dies  
 3.0 x .50 tap - 2.50 drill, dies  
 3.5 x .60 tap - 2.90 drill, dies  
 4.0 x .70 tap - 3.30 drill, dies

#### Middle drawer holds:

5.0 x .80 tap - 4.20 drill, dies  
 6.0 x 1.0 tap - 5.00 drill, dies  
 8.0 x 1.25 tap - 6.70 drill, dies



EDP #13595

#### Bottom drawer holds:

10.0 x 1.50 tap - 8.50 drill, dies  
 12.0 x 1.75 tap - 10.20 drill, dies

**Dimensions:** 14-5/8" W x 7-3/8" D x 7-3/4" H.

**Weight:** 10-1/4 lbs.

Phosphate pretreatment and finished in Huot's battleship gray powder coating for good looking inventory control and long useful life.

## Under-mount Drill Dispensers

**EDP# 30000** for fractional drills 1/16" to 1/2" x 64ths

**EDP# 30025** for wire gage drills #1 to #60

**EDP# 30050** for A to Z letter drills

**EDP# 30001** empty under-mount drawer, no dividers, for miscellaneous storage.

**Overall Dimensions:** 26-1/8" W x 12-1/2" D x 4-1/2" H.

**Drawer Dimensions:** 23-1/8" W x 11" D x 3" H.

**Weight:** 14 1/2 lbs.

The latest thing in organizing, sorting, storing, and securing your cutting tools is the new Huot Under-mount Dispenser. The outer shell can be mounted underneath a work bench, desk, shelf,

inside a cabinet, just about anywhere! And the drawer has a built in cam-lock to keep your cutting tools safely locked away along with heavy-duty ball bearing drawer slides.

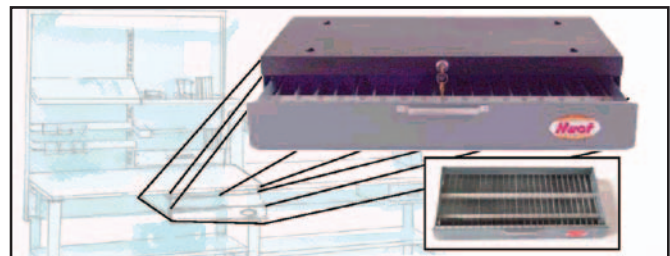

## 2 or 4 Flute & Metric End Mill Dispensers, Master

### EDP #13300

For fractional 2-Flute End Mills. Holds popular sizes 1/16" to 1". Lockable. Stackable.

### EDP #13325

For fractional 4-Flute End Mills. Holds popular sizes 1/16" to 1". Lockable. Stackable.

### EDP #13375

Metric end mills are separated and identified from 2.0mm to 25.0mm. 68 pre-labeled compartments help you quickly locate the proper cutting tool. Holds the following metric end mills: 2.0mm, 2.5mm, 3.0mm, 3.5mm, 4.0mm, 4.5mm, 5.0mm, 5.5mm, 6.0mm, 7.0mm, 8.0mm, 9.00mm, 10.0mm, 11.0mm, 12.0mm, 12.5mm, 13.0mm, 14.0mm, 15.0mm, 16.0mm, 17.0mm, 18.0mm, 19.0mm, 20.0mm, 21.0mm, 22.0mm, 23.0mm, 24.0mm, 25.00mm.

#### Top Drawer 41 Compartments (13300 & 13325)

Holds 6 each single end fractional end mills in following sizes: 1/8", 3/16", 1/4", 5/16", 3/8", 7/16" and 1/2". 3 each 5/8", 3/4", 7/8", and 1" with 6 extra compartments for specials.

#### Middle Drawer 41 Compartments

Holds 6 each double end fractional end mills in following sizes: 1/16", 3/32", 1/8" with 3/16" shank, 1/4" with 3/8" shank, 5/16", 3/8" with 7/16" shank, 3/8" with 1/2" shank, 1/4", 5/16", 3/8", 7/16" and 1/2". 3 each 5/8", 3/4", 7/8" and 1".



EDP #13300

#### Lower Drawer Undivided

Use for extra end mills, cutters, drills, reamers and miscellaneous tools.

Optional Drawer Divider Kit #14030 fits drawer, see page 22.

**Dimensions:** All models 26" W x 12" D x 9 1/16" H.

Each drawer measures 23 1/8" W x 11" D x 2" H.

Each drawer with ball bearing slides.

**Weight:** 40 lbs. ea.

## End Mill Dispenser, Original

### EDP #13350

#### For Small Inventories

1 Compartment for 1/16", 1/8", 3/16"

2 Compartments for 1/4", 5/16", 3/8", 1/2", 5/8", 1"

3 Compartments for 1/8", 1/4", 3/8", 1/2"

4 Compartments for 1/2"

**Dimensions:** Measures 14 3/8" W x 7 3/8" D x 7 3/4" H.

**Weight:** 10 1/4 lbs.



EDP #13350

Use protective webbing shown on page 20 to help protect tool edge.

## Reamer Cabinets, Master

### Model 196 EDP #13400

• Stores following reamers:

1/16"-4 ea., .1230 d/p, .1240 under, .1247 d/p, .1260 over, 3 ea.

3/16", .1855 d/p, .1865 under, .1870 d/p, .1885 over, 3 ea.

1/4"-4 ea., .2480 d/p, .2490 under, .2495 d/p, .2510 over, 3 ea.

5/16"-3 ea., .3105 d/p-3 ea., .3115 under 2 ea., .3120 d/p-2ea.,

.3135 over-2 ea. 3/8"-4 ea., .3730 d/p, .3740 under, .3745 d/p,

.3760 over, 3 ea. 7/16", .4355 d/p, .4365 under, .4370 d/p,

.4385 over, 2 ea. 1/2"-4 ea., .4980 d/p-2 ea., .4990 under,

.4995 d/p, .5010 over, 3 ea.

• Lockable, Stackable.

• Ball bearing drawer slides.

**Dimensions:** 26" W x 12" D x 9 5/16" H

**Weight:** 40 lbs.



EDP #13400

### EDP #13450

Fractional Reamers 1/16" to 1/2"

Over/Under Reamers from .1240 to .5010

Dowel Pin Reamers from .1230 to .4995

Metric Reamers from 1.0mm to 13.0mm x .5

**Dimensions:** 26" W x 12" D x 12 1/2" H. **Weight:** 50 lbs.

## Reamer Cabinets, Original

- 4 models for reamer organization.
- Ideal where compact space is a must.
- Decimal equivalents also listed.

### EDP #13410

Fractional Reamers  $\frac{1}{6}$ " to  $\frac{1}{2}$ " by 64ths,  
Weighs 13 lbs.-4 drawers.

### EDP #13415

A to Z Reamers  
Weighs 13 lbs.-3 drawers.



EDP #13410

### EDP #13420

Wire gauge sizes #1 to #60,  
Weighs 14 lbs.-5 drawers.

### EDP #13425

Metric reamer dispenser holds 1mm to  
13mm x 0.5mm. Weighs 14 lbs

### EDP #13430

Combination cabinet for over/under and  
dowel pin sizes, Weighs 11 lbs.-3 drawers.

**Dimensions:** All 5 models measure  
14 $\frac{5}{8}$ " W x 7 $\frac{3}{4}$ " D x 7 $\frac{3}{4}$ " H.

## Insert Dispenser, Master & Original

### Model 318 EDP #13600

- Holds Square, Triangular, Diamond and Round Inserts, with additional space for Specials.
- 36 Compartments to hold packages or loose inserts. Measures 3 $\frac{3}{4}$ " W x 5 $\frac{1}{2}$ " D.
- Pre-labeled for insert shape.
- Label set included for your personalized marking of size, radius, grind and thickness.
- Lockable and comes with set of two keys.
- Stackable with other dispensers.
- Ball bearing drawer slides.

**Dimensions:** 26" W x 12" D x 12 $\frac{1}{2}$ " H.

**Weight:** 50 lbs.

### Model 418 EDP #13650

- Designed to keep inserts at each work center.
- Compact size and affordable price lets the user keep the most frequently used inserts within fingertip reach.
- Three drawers have a moveable divider with a large fourth drawer to store tool holders and extra inserts.
- Label holders on drawer fronts permit easy, quick identification and inventory check.



EDP #13600



EDP #13650

- Stackable with other cutting tool storage cabinets to save space.

**Dimensions:** 14 $\frac{5}{8}$ " W x 7 $\frac{3}{4}$ " D x 7 $\frac{3}{8}$ " H.

**Weight:** 13 lbs.

## Counterbore Dispenser, Original

### EDP #13570

Holds continuous pilot counterbores 4, 5, 6,  
8, 10, 12, 1/4, 5/16, 3/8, 7/16 & 1/2"

**Dimensions:** 14 $\frac{5}{8}$ " W x 7 $\frac{3}{8}$ " D x 7 $\frac{3}{4}$ " H.

**Weight:** 14 pounds.



EDP #13570

## Super Chest and Super Cabinet

- Solid welded drawer dividers front to back provide a rigid smooth surface with no holes to lose parts.
- 24,000 combined cubic inches of usable storage space.
- Heavy duty cam lock and hidden locking mechanism.
- Rugged, exclusive I-beam doublewall construction.
- 18 gauge, all steel construction with Huot's Ecolo-Clad plastic paint. Environmentally safe finish.
- Steel skid keeps unit off floor and allows for stacking for even greater space savings.
- Stackable. Two high maximum.
- Label holders provide identification at a glance.
- Each drawer rigidly constructed of solid steel with no holes in drawer bottom to keep small parts inside of drawer. Will hold 150 lbs. supported on **full extension ball bearings slides**.
- Deeper drawers available.

### Model 530 EDP #13530

Super chest with 8 drawer capacity. 240 individual drawer dividers included.

**Dimensions:** 34" W x 19 1/8" D x 23 1/8" H.  
**Weight:** 220 lbs.

### Model 525 EDP #13525

Super cabinet with 15 drawer capacity. 480 individual drawer dividers included.

**Dimensions:** 34" W x 19 1/8" D x 38" H.  
Each drawer measures 29" W x 18" D x 2" H.  
**Weight:** 375 lbs.



**EDP #13530**  
**Super Chest**  
**stacked on**  
**EDP #13525**  
**Super Cabinet**



**EDP #13527**



**No holes in  
drawer bottom**

**3/4"  
wide**

**Front to back dividers  
welded into position**



**Metal drawer divider  
Kit #8755**

### Model 527 EDP #13527

Super cabinet with 8 drawer capacity.  
7 drawers 4" high, 1 drawer 2" high.  
480 individual drawer dividers provided.

**Dimensions:** 34" W x 19 1/8" D x 38" H.  
Each drawer measures 29" W x 18" D x 2" H.  
**Weight:** 375 lbs.

**Huot Mfg. Co. does not manufacture or  
distribute cutting tools of any type.  
Cutting tools shown in all photos are  
for display purposes only.**

## Bit Buddy

Bit Buddy is all plastic, break resistant and water resistant, durable and holds Jobbers length or Mechanics length drill bits.

### EDP #30550

For Jobbers length drills  $\frac{1}{16}$ " to  $\frac{1}{2}$ " by 64ths.

### EDP #30650

For Mechanics length drills  $\frac{1}{16}$ " to  $\frac{1}{2}$ " by 64ths.

**Huot Mfg. Co. does not manufacture or distribute cutting tools of any type. Cutting tools shown in all photos are for display purposes only.**



EDP #30550

EDP #30650

## Combination Indexes

Ideal for keeping all of the most commonly used drills handy. Holds up to 135 drills in one combination case. Indexed for size and decimal equivalents.

### Model 115 EDP #11700

Holds 115 drills-29 fractional, 26 letter and 60 wire gauge;  $\frac{1}{16}$ " to  $\frac{1}{2}$ " by 64ths, 1 to 60, A to Z letter size. (Stub version EDP #11550 available see page 18).

### Model 135 EDP #11750

Same features as Model #115 above but includes the #61-80 wire gauge sizes in one complete index. Holds 135 drills.



EDP #11700

### Model 134 EDP #11800

Holds 134 drills-29 fractional, #80 wire gauge and 25 metric;  $\frac{1}{16}$ " to  $\frac{1}{2}$ " by 64ths #1 to #80 wire gauge, 1mm to 13mm by 0.5mm.

**Dimensions:** All combination indexes measure  $1\frac{1}{2}$ " W x  $4\frac{3}{4}$ " D x  $2\frac{1}{4}$ " H.

**Weight:** 4 lbs.

### Model #118 EDP #11825

Holds 118 most popular metric bits from 1.0mm to 13.0mm. See metric indexes below for full description.

**Dimensions:**  $13\frac{3}{8}$ " L x  $4\frac{1}{2}$ " W x  $2\frac{3}{4}$ " H.

**Weight:** 4 lbs.

## Drill Indexes/Metric

### Model 118 EDP #11825

Holds 118 most popular metric bits from 1.0mm to 13.0mm. Sizes include: 1.00mm to 2.50mm by .05mm, 2.6mm to 10.0mm by .1mm, 10.2mm, 10.5mm, 10.8mm, 11.0mm, 11.2mm, 11.5mm, 11.8mm, 12.0mm, 12.2mm, 12.5mm, 12.8mm, and 13.0mm.

U.S. decimal equivalents are given for each size drill.

**Dimensions:**  $13\frac{3}{8}$ " L x  $4\frac{1}{2}$ " W x  $2\frac{3}{4}$ " H.

**Weight:** 4 lbs.

### Model 4011 EDP #11000

1mm to 6mm inclusive by 0.5mm  
**Dimensions:** 4" W x  $5\frac{1}{2}$ " D x  $\frac{1}{2}$ " H.



EDP #11250

### Model 4013 EDP #11050

1mm to 7mm inclusive by 0.5mm  
**Dimensions:** 4" W x  $5\frac{1}{2}$ " D x  $\frac{1}{2}$ " H.

### Model 4019 EDP #11100

1mm to 10mm by 0.5mm inclusive.  
**Dimensions:** 4" W x 6" D x  $1\frac{1}{8}$ " H.

### Model 4025 EDP #11150

1mm to 13mm by 0.5mm inclusive.

**Dimensions:** 4" W x 7" D x  $1\frac{1}{4}$ " H.

### Model 4041 EDP #11200

6mm to 10mm by 0.1mm inclusive.

**Dimensions:**  $4\frac{1}{2}$ " W x  $7\frac{7}{8}$ " D x  $2\frac{1}{2}$ " H.

### Model 4050 EDP #11250

1mm to 5.9mm by 0.1mm inclusive.

**Dimensions:**  $3\frac{1}{4}$ " W x  $4\frac{1}{2}$ " D x 1" H.

### Model 12765 EDP #12765

Holds 1.0, 1.2, 1.5, 2.0, 2.5, 3.0, 3.5, 4.0, 4.5, 5.0, 5.5, 6.0, 6.5.

**Dimensions:** 4" W x  $5\frac{3}{8}$ " D x  $\frac{5}{16}$ " H.



## Drill Indexes/U.S.

### Model 313 EDP #12750

For jobbers length fractional drills  $\frac{1}{16}$ " to  $\frac{1}{4}$ " inclusive by 64ths. Also available in plastic, see #16000 listed below.

**Dimensions:** 4" W x  $5\frac{3}{8}$ " D x  $\frac{5}{16}$ " H.

### Model 15 EDP #10350

For jobbers length fractional drills  $\frac{1}{16}$ " to  $\frac{1}{2}$ " inclusive by 32nds.

**Dimensions:** 4" W x 7" D x  $1\frac{1}{4}$ " H.

### Model 20 EDP #10400

For wire gauge drills No. 61 to 80.

**Dimensions:**  $1\frac{1}{2}$ " W x 2" D x  $\frac{5}{8}$ " H.

### Model 21 EDP #10450

For jobbers length fractional drills  $\frac{1}{16}$ " to  $\frac{3}{8}$ " inclusive by 64ths.

**Dimensions:** 4" W x 6" D x  $1\frac{1}{8}$ " H.

### Model 26 EDP #10500

For letter size drills A to Z inclusive.

**Dimensions:** 4" W x 7" D x  $1\frac{3}{4}$ " H.

### Model 29 EDP #10550

For jobbers length fractional drills  $\frac{1}{16}$ " to  $\frac{1}{2}$ " by 64ths inclusive. Decimal equivalents and U.S.S. tap information included.

**Dimensions:** 4" W x 7" D x  $1\frac{1}{4}$ " H.



EDP #12750

### Model 60 EDP #10600

For wire gauge drills #1 to #60 inclusive. Decimal equivalents and machine screw tap information included.

**Dimensions:**  $3\frac{1}{4}$ " W x  $4\frac{1}{2}$ " D x 1" H.

### Model 80 EDP #10700

For wire gauge drills 1 to 80 inclusive.

**Dimensions:**  $3\frac{1}{4}$ " W x  $4\frac{1}{2}$ " D x  $1\frac{5}{16}$ " H.

### Model 1316 EDP #10800

For jobbers length fractional drills  $\frac{1}{64}$ " to  $\frac{1}{4}$ " by 64ths.

**Dimensions:** 4" W x  $5\frac{3}{8}$ " D x  $\frac{5}{16}$ " H.

### Model 2100 EDP #12300

For  $\frac{1}{16}$ " to  $\frac{1}{4}$ " by 64ths and  $\frac{3}{32}$ " to  $\frac{1}{2}$ " by 32nds, jobbers length.

**Dimensions:** 4" W x 7" D x  $1\frac{1}{4}$ " H.

### Model 119 EDP #10875

#### Maintenance Index

19 piece index holds every drill needed for frequent maintenance work in one handy index case. Holds  $\frac{1}{16}$ ",  $\frac{5}{64}$ ",  $\frac{3}{32}$ ",  $\frac{1}{8}$ ", #29, #25,  $\frac{5}{32}$ ", #21,  $\frac{3}{16}$ ", #7,  $\frac{7}{32}$ ",  $\frac{1}{4}$ ", #F,  $\frac{5}{16}$ ", #U,  $\frac{3}{8}$ ",  $\frac{27}{64}$ ",  $\frac{7}{16}$ ",  $\frac{1}{2}$ ".

**Dimensions:** 4" W x 7" D x  $1\frac{1}{4}$ " H.

### EDP #11655

Holds 6" OAL aircraft extension bits from  $\frac{1}{16}$ " to  $\frac{1}{2}$ " by 64ths.

**Dimensions:** 4" W x 2" D x  $8\frac{3}{4}$ " H.

**Weight:** 1.5 pounds.

### EDP #15235

Holds jobber length drills  $\frac{1}{8}$ ",  $\frac{3}{16}$ ",  $\frac{1}{4}$ ",  $\frac{5}{16}$ ",  $\frac{3}{8}$ ",  $\frac{7}{16}$ ",  $\frac{1}{2}$ ".

**Dimensions:** 4" W x 7" D x  $1\frac{1}{4}$ " H.

**For metric sizes see page 16**

## Screw Extractor & Transparent Drill Index

### Model 55 EDP #10200

Holds #1, #2, #3, #4, #5 screw extractor and corresponding size drill bit.

**Dimensions:** 4" W x  $5\frac{1}{2}$ " D x  $\frac{1}{2}$ " H.

### EDP #16000

$\frac{1}{16}$ " to  $\frac{1}{4}$ " x 64ths. Holds 13 drills.

Transparent plastic/steel drill index displays and merchandises your 13-piece drill set. With our exclusive Securitab<sup>®</sup> locking feature. No additional packaging required. No blister pack, no shrink-wrap, nothing else required.



EDP #10200

Fill the case with your drills, close and the product is locked safely inside until the consumer cuts the locking tab for use. Minimum order 1,000 pieces.

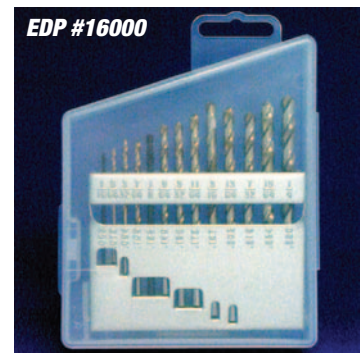

EDP #16000

## Reamer Cases

These handy, all-steel reamer cases are designed to hold the reamer securely by the shank to help protect delicate cutting edges. Indexed for reamer size in decimal equivalents, with raised embossed lettering for permanent identification.

### Model 14 EDP #12100

Over and Under sizes .124-.126 to .499-.501 by 16ths. Holds 14 reamers.

**Dimensions:** 4" W x  $8\frac{5}{8}$ " D x  $1\frac{1}{16}$ " H.

### Model 12125 EDP #12125

For dowel pin reamers .123 to .4995. Holds 14 reamers.

**Dimensions:** 4" W x  $8\frac{5}{8}$ " D x  $1\frac{1}{16}$ " H.



EDP #12050

### Model 126 EDP # 12000

A to Z reamers.

**Dimensions:** 4" W x  $8\frac{5}{8}$ " D x  $1\frac{13}{16}$ " H.

### Model 129 EDP #12050

Chucking reamers  $\frac{1}{16}$ " to  $\frac{1}{2}$ " by 64ths.

**Dimensions:** 4" W x  $8\frac{5}{8}$ " D x  $1\frac{13}{16}$ " H.

### Model 160 EDP #12200

No.1 to 60 inclusive.

**Dimensions:**  $3\frac{3}{8}$ " W x  $6\frac{3}{4}$ " D x  $1\frac{1}{16}$ " H.

### Model 125 EDP #12130

For metric reamers 1.00mm to 13.00mm by 0.5mm. Holds 25 reamers in an all steel case with easy to read mylar identification labels to pick the right size quickly and easily.

**Dimensions:**  $8\frac{3}{4}$ " W x 4" D x  $1\frac{1}{4}$ " H.

## Silver Deming

### Model 88SD EDP #10760

For drills:  $\frac{9}{16}$ " to 1" by 16ths. Holds eight S/D drills securely by the  $\frac{1}{2}$ " shank.

**Dimensions:** 8 $\frac{1}{2}$ " L x 6 $\frac{1}{4}$ " W x 2" H.

**Weight:** 2 $\frac{1}{2}$  lbs.

(See page 19 for S/D stand)



Three index cases to complete S/D drills from  $\frac{1}{2}$ " to 1" by 64ths

### EDP #10761

15 S/D drills  $\frac{1}{2}$ " to  $\frac{23}{32}$ " by 64ths

### EDP #10762

10 S/D drills  $\frac{47}{64}$ " to  $\frac{7}{8}$ " by 64ths

### EDP #10763

8 S/D drills  $\frac{57}{64}$ " to 1" by 64ths

**Dimensions:** 8 $\frac{1}{2}$ " L x 6 $\frac{1}{4}$ " W x 2" H.

**Weight:** 2 $\frac{1}{2}$  lbs.

## Taper Shank/Taper Length

### Model 1016 EDP #10900

For Morse taper shank and taper length straight shank drills  $\frac{33}{64}$ " to  $\frac{3}{4}$ " by 64ths.

**Dimensions:** 5 $\frac{1}{2}$ " W x 12 $\frac{7}{8}$ " D x 3 $\frac{1}{8}$ " H.

### Model 2016 EDP #10950

For Morse taper shank and taper length straight shank drills  $\frac{49}{64}$ " to 1" by 64ths.

**Dimensions:** 6 $\frac{3}{8}$ " W x 15 $\frac{1}{8}$ " D x 3 $\frac{1}{16}$ " H.



### Model 326 EDP #11525

A to Z letter size taper length.

**Dimensions:** 8 $\frac{3}{4}$ " W x 4" D x 1 $\frac{3}{4}$ " H.

### Model 329 EDP #11600

$\frac{1}{16}$ " to  $\frac{1}{2}$ " by 64ths taper length.

**Dimensions:** 8 $\frac{3}{4}$ " W x 4" D x 1 $\frac{3}{4}$ " H.

### Model 360 EDP #11650

1 to 60 wire gauge taper length.

**Dimensions:** 6 $\frac{3}{8}$ " W x 3 $\frac{1}{2}$ " D x 1 $\frac{1}{4}$ " H.

## Stub Screw Machine Indexes

### Model 2013 EDP #11300

Index for stub screw machine length fractional drills  $\frac{1}{16}$ " to  $\frac{1}{4}$ " by 64ths.

**Dimensions:** 4" W x 5 $\frac{3}{8}$ " D x  $\frac{5}{8}$ " H.

### Model 2021 EDP #11350

Index for stub screw machine length fractional drills  $\frac{1}{16}$ " to  $\frac{3}{8}$ " by 64ths.

**Dimensions:** 4" W x 4 $\frac{5}{8}$ " D x  $\frac{5}{8}$ " H.

### Model 2025 EDP #11375

For metric stub drills 1 to 13 mm by 0.5 mm. Decimal equivalents and screw information included.

**Dimensions:** 4" W x 7" D x 1 $\frac{1}{4}$ " H.

### Model 2026 EDP #11400

For stub screw machine letter drills A to Z.

**Dimensions:** 4" W x 7" D x 1 $\frac{1}{4}$ " H.



### Model 2029 EDP #11450

Index for stub screw machine length fractional drills,  $\frac{1}{16}$ " to  $\frac{1}{2}$ " by 64ths. Decimal equivalents and U.S.S. tap information included.

**Dimensions:** 4" W x 7" D x 1 $\frac{1}{4}$ " H.

### Model 2060 EDP #11500

For stub screw machine length drills wire gauge #1 to #60 inclusive, decimal equivalents and screw tap information.

**Dimensions:** 3 $\frac{1}{4}$ " W x 4 $\frac{1}{2}$ " D x 1" H.

### Model 11550 EDP #11550

Holds 115 stub screw machine length drills in one case. See the Combination Index section for additional details. For stub drills  $\frac{1}{16}$ " to  $\frac{1}{2}$ " by 64ths, 1 to 60 wire gauge and A to Z letter size.

**Dimensions:** 13 $\frac{1}{2}$ " W x 4 $\frac{5}{8}$ " D x 2 $\frac{1}{4}$ " H.

## Carbide Burr & Needle File Indexes

Safely separates and holds carbide burrs of all types.

**EDP #15030** Holds 8 pieces 1/4" shank.

**EDP #15035** Holds 10 pieces 1/4" shank.

**EDP #15040** Holds 8 pieces 1/8" shank.

**EDP #10010** Holds 12 round handle needle files for quick access on bench or tool box drawer. All steel with Huot's Ecolo-Clad finish.

**Dimensions:** 6 $\frac{3}{4}$ " W x 4 $\frac{1}{4}$ " D x  $\frac{3}{4}$ " H.



## Tap Indexes

### Model 10 EDP #12575

Holds coarse and fine

1/4" - 20	1/4" - 28
5/16" - 18	5/16" - 24
3/8" - 16	3/8" - 24
7/16" - 14	7/16" - 20
1/2" - 13	1/2" - 20

### Model 19 EDP #12550

Holds fine and coarse

0 - 80	5 - 40	5 - 44	
1 - 72	1 - 64	6 - 32	6 - 40
2 - 56	2 - 64	8 - 32	8 - 36
3 - 48	3 - 56	10 - 24	10 - 32
4 - 40	4 - 48	12 - 24	12 - 28



EDP #12575



EDP #12550

### EDP #12590

Holds the following 10 U.S. tap sizes:

4-40NC	1/4"-20NC
6-32NC	5/16"-18NC
8-32NC	3/8"-16NC
10-24NC	1/2"-13NC
10-32NF	5/8"-11NC

Or the following 10 metric tap sizes:

16 x 2.0	5 x .8
12 x 1.75	4.5 x .75
10 x 1.5	4 x .7
8 x 1.25	3.5 x .6
6 x 1.0	3 x .5

**Dimensions:** All models measure 3 1/4" W x 4 1/2" D x 1" H.

## Tap and Drill Indexes

### Model 36 EDP #12700

Conveniently combines taps with the corresponding tap drill alongside of one another.

- National Fine
- Holds sizes: 6-40 tap #33 drill, 8-36 #29, 10-32 #21, 12-28 #15, 1/4"-28 #3, 5/16"-24 #1, 3/8"-24 #Q, 7/16"-20 #25/64, 1/2"-20 #27/64.
- National Coarse
- Holds sizes: 6-32 tap #36 drill, 8-36 #29, 10-24 #25, 12-24 #16, 1/4"-20 #7, 5/16"-18 #F, 3/8"-16 #5/16", 7/16"-14 #U, 1/2"-13 #27/64.
- Clips mounted in the cover provide a handy place for securing your T-handle or adjustable tap wrench.

**Dimensions:** 13 1/2" W x 4 1/2" D x 2 3/4" H.

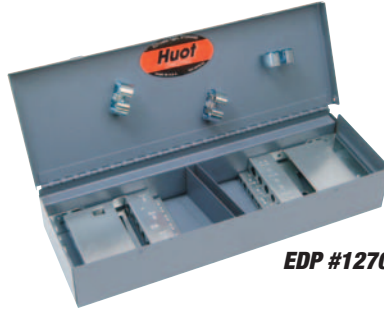

EDP #12700

### Model 99 EDP #12600

- National Coarse
- Holds sizes: 6-32 tap #36 drill, 8-32 #29, 10-24 #25, 10-32 #21, 1/4"-20 #7, 5/16"-18 #F, 3/8"-16 #5/16", 7/16"-14 #U, 1/2"-13 #27/64.

**Dimensions:** 4" W x 7" D x 1 1/4" H.

### Model 18 EDP #12650

- National Fine
- Holds sizes: 6-40 tap #33 drill, 8-36 #29, 10-24 #25, 10-32 #21, 1/4"-28 #3, 5/16"-24 #1, 3/8"-24 #Q, 7/16"-20 #25/64, 1/2"-20 #27/64.

**Dimensions:** 4" W x 7" D x 1 1/4" H.

### Metric Model 4099 EDP #12675

- I.S.O. 529 1975
- Holds Sizes: 2.5 x 0.45 tap 2.05 drill, 3.0 x 0.50 2.50, 3.5 x 0.60 2.90, 4.0 x 0.70 3.30, 5.0 x 0.80 4.20, 6.0 x 1.00 5.00, 8.00 x 1.25 6.70, 10.0 x 1.50 8.50, 12.0 x 1.75 10.20

**Dimensions:** 4" W x 7" D x 1 1/4" H.

## Silver Deming

### EDP #11980

Conveniently holds 8 most commonly used Silver Deming drills 9/16" to 1" by 64ths.

**Dimensions:** 5 5/8" W x 2 5/8" D x 1 1/2" H.

**Weight:** 1 pound.

- Can be mounted to drill press or work bench.

- Textured black with sizes in white for easy reading.

### Model 833SD EDP #11985

For Silver Deming drills from 1/2" to 1" by 64ths "held by shank".

**Dimensions:** 13" W x 5" D x 2" H.

**Weight:** 3 lbs.



EDP #11980



EDP #11985

## Carbide Burr Stand

### Model 824 EDP #11875

Holds 24 each, 1/4" shank burrs.

**Dimensions:** 5 5/8" W x 2 5/8" D x 1 1/2" H.



EDP #11875

- Holds up to 24, 1/4" shank burrs. Mounts on wall or drill press for easy accessibility.
- Made from a single piece of steel.

## Drill Stands, Jobber or Stub Screw

### Model 826 EDP #11850

Letter sizes A to Z inclusive

**Dimensions:** 5 $\frac{5}{8}$ " W x 2 $\frac{5}{8}$ " D x 1 $\frac{1}{2}$ " H.

### Model 829 EDP #11900

Fractional drills  $\frac{1}{16}$ " to  $\frac{1}{2}$ " by 64ths inclusive.

**Dimensions:** 5 $\frac{5}{8}$ " W x 2 $\frac{5}{8}$ " D x 1 $\frac{1}{2}$ " H.

### Model 833 EDP #11975

For jobbers and stub or screw machine length from  $\frac{1}{2}$ " to 1" by 64ths "held by flute".

**Dimensions:** 13" W x 5" D x 2" H.

**Weight:** 3 lbs.

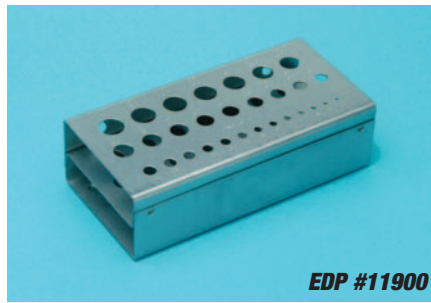

EDP #11900

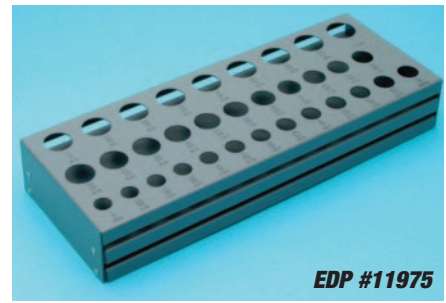

EDP #11975

## Drill Gauges

### Model 9092 EDP #12250

For measuring  $\frac{1}{16}$ " to  $\frac{1}{2}$ " by 64ths drill bits.

**Dimensions:** 6" W x 3" D.

### EDP #12260

For measuring #1 to 60 wire gauge drill bits.

**Dimensions:** 5 $\frac{1}{4}$ " W x 2" D.

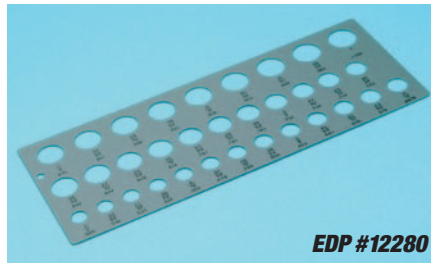

EDP #12280

### EDP #12280

For measuring drills  $\frac{1}{2}$ " to 1" by 64ths.

**Dimensions:** 13" W x 5" D.

## Protective Cover



Cover provides protection for your valuable CNC tooling. The see-through front and back panels provide "at-a-glance" locating of the right toolholders needed for your job while protecting them from chips, dirt, dust and other airborne contaminants. Multiple H.D.#5 nylon zippers allow easy access from either side and from top to bottom. Cover is for the original ToolScoot only. Will not work on Super or Speedy versions.

Cover comes with rigid metal support frames that bolt onto your Huot ToolScoot providing 18" of space between the top shelf and the top of the cover. Cover is commercially sewn from rugged 19 mil, double polished clear vinyl and black 18 oz. vinyl-coated nylon.

**EDP #14875** ToolScoot Cover

**Dimensions:** 27 $\frac{1}{2}$ " W x 19" D x 44 $\frac{1}{2}$ " H.

**Weight:** 16 lbs.

## Webbing

- Woven of tough, flexible and stretchable polyethylene.
- Great protection for delicate edges of cutting tools.
- Doubles/triples storage capacity of any drawer.
- Reusable. Slips on and off easily. Elasticity assures snug fit and non-slip grip.
- Easily cuts to any length.
- Inexpensive protection.

### EDP #14025

50 ft. of material for  $\frac{1}{4}$ " to  $\frac{1}{2}$ " dia. tools.

50 ft. of material for  $\frac{1}{2}$ " to 1" dia. tools.

### EDP #14026

100 ft. of material for  $\frac{1}{4}$ " to  $\frac{1}{2}$ " dia. tools.



EDP #14025

### EDP #14027

100 ft. of material for  $\frac{1}{2}$ " to 1" dia. tools.

### EDP #14028

50 ft. of material for 1" to 1 $\frac{1}{2}$ " dia. tools.

### EDP #14047

50 ft. of material for 1 $\frac{1}{2}$ " to 2" dia. tools.

### EDP #14048

50 ft. of material for 2" to 2 $\frac{1}{2}$ " dia. tools.

### EDP #14049

50 ft. of material for 2 $\frac{1}{2}$ " to 3" dia. tools.

### EDP #14050

50 ft. of material for 3" to 4" dia. tools.

### EDP #14051

50 ft. of material for 4" to 5" dia. tools.

### EDP #14052

50 ft. of material for 5" to 6" dia. tools.

### EDP #14053

50 ft. of material for 6" to 7" dia. tools.

### EDP #14054

50 ft. of material for 7" to 9" dia. tools.

## V-Flange and HSK NC Racks

- Holds NC Toolholders, Collets and Tap Adapters
- Angled for easier selection of stored tools.
- Mounts on bench top or fits neatly inside standard 36" industrial cabinet.
- Heavy gauge steel with tough, solvent free, epoxy finish Ecolo-Clad.

### Model 4550 EDP #14700

45 or 50 Taper NC Tool Holder has: 9 spaces for toolholders, 7 spaces for Tap Drivers or DA-180 Series Collets, 8 spaces for DA-180 Series, 10 spaces for DA-200 Series, 9 spaces for DA-300 Series.

**Dimensions:** 12½" W x 16½" D x 6¾" H.

**Weight:** 5½ lbs.



### Model 3540 EDP #14725

35 or 40 Taper NC rack has 12 spaces for toolholders, 7 spaces for Tap Drivers or DA-180 Series Collets, 8 spaces for DA-180 Series, 10 spaces for DA-200 Series, 9 spaces for DA-300 Series.

**Dimensions:** 12½" W x 16½" D x 6¾" H.

**Weight:** 5½ lbs.

### Model 14730 EDP #14730

30 Taper NC Tool Holder has 12 spaces for toolholders, 7 spaces for Tap Drivers or DA-180 Series Collets, 8 spaces for DA-180 Series, 10 spaces for DA-200 Series, 9 spaces for DA-300 Series.

**Dimensions:** 12½" W x 16½" D x 6¾" H.

**Weight:** 5½ lbs.

**Heavy gauge steel with epoxy powder finish**

## NC, HSK Tool Tote Rack for 40 and 50 Taper

Bench mount, hand carry, or mount on top of your shop cart to move your 40 and 50 taper tools to the job. Made of heavy gauge steel with nylon inserts to help protect your tooling, painted texture black with Huot's pollution free powder coating process. Built-in end handles for comfortable carrying.

**Dimensions:** 28¾" L x 5¼" W x 6" H.

**Weight:** 6 lbs. each, packed one per carton.



**Built-in handles for comfortable carrying**

### EDP #14780

For 40 taper tools, holds six tools.

### EDP #14790

For 50 taper tools, holds five tools.

### EDP #14770

For HSK 63A, holds six tools.

### EDP #14775

For HSK 100A, holds five tools.

## Can or Spray Bottle Rack

### EDP #14757

The Can Rack easily mounts just about anywhere. Oils, aerosols, cleaners and "whatever" conveniently within your reach.



### EDP #14759

Holds larger (24 oz.) spray bottle and cans with a 3.5" diameter hole. Reduces refill trips by accommodating larger bottles of sprays, liquids and lubricants.

## 5C, R8 Collet Racks

- Angled for visibility and easier selection of stored collets.
- Mountable on bench top.
- Tough, solvent free, epoxy finish Ecolo-Clad for long lasting protection.
- Heavy gauge steel.



### EDP #14600

Holds up to 30 pieces 5C Collets.

**Dimensions:** Top 9" W x 12" D.

**Weight:** 3 lbs.



### EDP #14625

Holds up to 17 R8 Collets.

**Dimensions:** Top 5¼" W x 9" D.

**Weight:** 2 lbs.

## Collet Racks for ER/RD/DR/DA/TG

### EDP #14800

Holds up to (49) 11 Series Collets ER/RD/DR.  
Hole size  $\frac{27}{64}$ "

### EDP #14801

Holds up to (49) 16 Series Collets ER/RD/DR,  
or C-3 Sandvik Collets. Hole size  $\frac{39}{64}$ "

### EDP #14802

Holds up to (36) 20 Series Collets ER/RD/  
DR, or C-4 Sandvik Collets. Hole size  $\frac{49}{64}$ "

### Dimensions of previous 3 racks are:

$7\frac{7}{32}$ " W x  $9\frac{1}{8}$ " D x  $1\frac{3}{8}$ " H.

### EDP #14803

Holds up to (48) 25 Series Collets ER/RD/DR,  
Hole size  $\frac{61}{64}$ "

### EDP #14804

Holds up to (40) 32 Series Collets ER/RD/DR,  
Hole size  $1\frac{13}{64}$ "

### EDP #14805

Holds up to (27) 40 Series Collets ER/RD/DR,  
or C-8 Sandvik Collets. Hole size  $1\frac{1}{2}$ "

### EDP #14806

Holds up to (21) 50 Series Collets ER/RD/DR.  
Hole size 2"



EDP #14812

### Dimensions of previous 4 racks are:

17" W x  $9\frac{1}{8}$ " D x 2" H.

- Heavy 14 gauge steel finished with durable epoxy, powder paint.
- All racks conveniently fit in the ToolScoot and ToolTower storage trays.
- Mountable on bench top.
- Protects, stores and organizes your valuable collets.
- Models 14800, 14801, 14802, 14810, 14811 and 14813 fit within 2.0" drawer.

### EDP #14810

Holds up to 49 DA300 Collets. Hole size  $\frac{5}{16}$ "

### EDP #14811

Holds up to 49 DA200 Collets. Hole size  $\frac{15}{32}$ "

### EDP #14813

Holds up to 36 DA100 Collets. Hole size  $\frac{43}{64}$ "

### Dimensions of previous 3 racks are:

$7\frac{7}{32}$ " W x  $9\frac{1}{8}$ " D x  $1\frac{3}{8}$ " H.

### EDP #14812

Holds up to 48 DA180 Collets. Hole size  $\frac{29}{32}$ "

### EDP #14820

Holds up to 40 TG75 Collets. Hole size  $1\frac{1}{32}$ "

### EDP #14821

Holds up to 27 TG100 Collets. Hole size  $1\frac{5}{16}$ "

### EDP #14822

Holds up to 21 TG150 Collets. Hole size  $1\frac{59}{64}$ "

### Dimensions of previous 4 racks are:

17" W x  $9\frac{1}{8}$ " D x 2" H.

## Wall Mounted Cabinet

### EDP #14100

**Dimensions:**  $17\frac{3}{4}$ " W x  $9\frac{1}{4}$ " D x  $24\frac{1}{2}$ " H.

**Weight:** 20 lbs.

Secure up to 3 original dispenser cabinets and locks using your own padlock with our new wall mounted cabinet. Featuring heavy 18 gauge prime steel powder coated in our exclusive Huot battleship gray.

Shipped KD and supplied with carriage bolts and nuts for easy assembly. Provide protected storage for your valuable cutting tool inventory. Wall mounted on 16" centers using your own mounting hardware.



EDP #14100



## Dispenser Drawer Divider kit

### EDP #14030

- Four sections create 25 compartments in Huot Master Series standard 11" x  $23\frac{1}{8}$ " dispenser drawers and most tool boxes.
- Individual compartments are each 11" deep x  $\frac{15}{16}$ " wide x 1" high.

### EDP #14060

- Four sections create 17 compartments  $1\frac{1}{4}$ " wide and 11" deep.

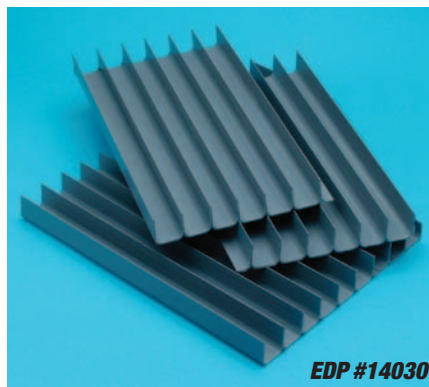

EDP #14030

- Vinyl compartments separate tools to prevent damage and organize inventory.
- Can be labeled for inventory control and tracking.
- Use in combination with Protective Vinyl Webbing to multiply drawer capacity.

## Molded Inserts for V-Flange and HSK Toolholders



- Part #9601** 30 Taper      **Part #9603** 35 Taper  
**Part #9606** 45 Taper  
**Part #9615** HSK 63A      **Part #9616** HSK 100A  
**Part #9617** 40 Taper      **Part #9618** 50 Taper

Toolholder inserts are molded using high impact plastic. The special plastic provides a highly durable material that is resistant to breakage and can withstand the weight of tooling over time without becoming brittle. With toolholder inserts 9615, 9616, 9617 and 9618, tapered tooling easily slips in to the form fitting holder, keeping the tooling safe from marring, nicks or chipping.

Part #	Desc.	Dim. A
9601	30 Taper	1.312"
9603	35 Taper	1.625"
9606	45 Taper	2.438"

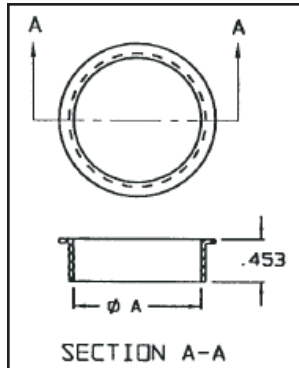

Part #	Desc.	Dim. A	Dim. B
9615	HSK 63 A	1.946"	1.818"
9616	HSK 100A	3.023"	2.824"

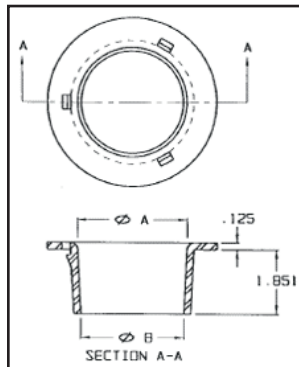

Part #	Desc.	Dim. A	Dim. B
9617	40 Taper	2.023"	1.252"
9618	50 Taper	3.023"	2.252"

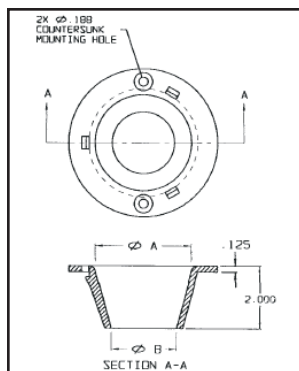

Fasten using Tek screw, #8 x 1/2" self drilling screw

### CARTS

ToolScoot Tree.....	2
SuperScoot.....	5
ToolScoot.....	3
TriScoot.....	6
SpeedyScoot.....	7
CAPTO & VDI Products.....	3, 6

### TOOLS COOT ACCESSORIES

Drawer.....	4
Doors.....	4
Safety Covers.....	4
Toolholder Vises.....	4

### TOWERS

SuperTower.....	5
ToolTower.....	3

### WALL MOUNTABLE

Wall or machine mount racks.....	6, 22
----------------------------------	-------

### BENCH TOP PLATFORMS

Racks.....	6, 21, 22
------------	-----------

### PORTABLE

Tool Totes.....	21
-----------------	----

### COVERS

ToolScoot covers.....	4, 20
-----------------------	-------

### DRILL DISPENSERS

Fractional.....	8-12
Wire.....	8-9, 12
Letter.....	8-9, 12
Silver Deming.....	10
Taper Shank/Length.....	10
Metric.....	8-9, 12

### TAP DISPENSERS..... 11-12

### TAP & DRILL DISPENSERS..... 11-12

### END MILL DISPENSERS..... 13

### REAMER DISPENSERS..... 13-14

### INSERT DISPENSERS..... 14

### BURR DISPENSER..... 10

### DISPLAYS, POINT OF PURCHASE..... 8

### INDEX CASES & STANDS

Drills.....	16-19
Metric.....	16
Reamers.....	17
Stub/Screw machine length.....	16, 18
Silver Deming.....	18-19
Screw Extractor.....	17
Taper Shank/Taper Length.....	18, 20
Tap.....	19
Burr.....	18
Stands.....	20
Tap & Drill.....	19
Needle file.....	18
Gauges.....	20

### COLLET RACKS..... 21-22

### CAN RACK, SPRAY BOTTLE RACK..... 21

# Cost Effective Tool Management & Storage

Drills • Taps • Reamers • End Mills • Inserts • Collets • CNC Tooling • Turret Tooling

Huot Manufacturing Company is one of the most respected names in cutting tool storage, CNC transport and CNC toolholder storage, with a world wide reputation for quality, innovation and service. Since 1926 Huot has been committed to outstanding quality and complete customer satisfaction.

The products in this catalog are a reflection of this commitment. Each is designed to effectively and efficiently meet your specific requirements. Each is quality made to meet the highest international standards of quality through ISO 9001:2000.

Only in this way can we earn your complete satisfaction and maintain your continued trust in our products.



Proudly Made In USA

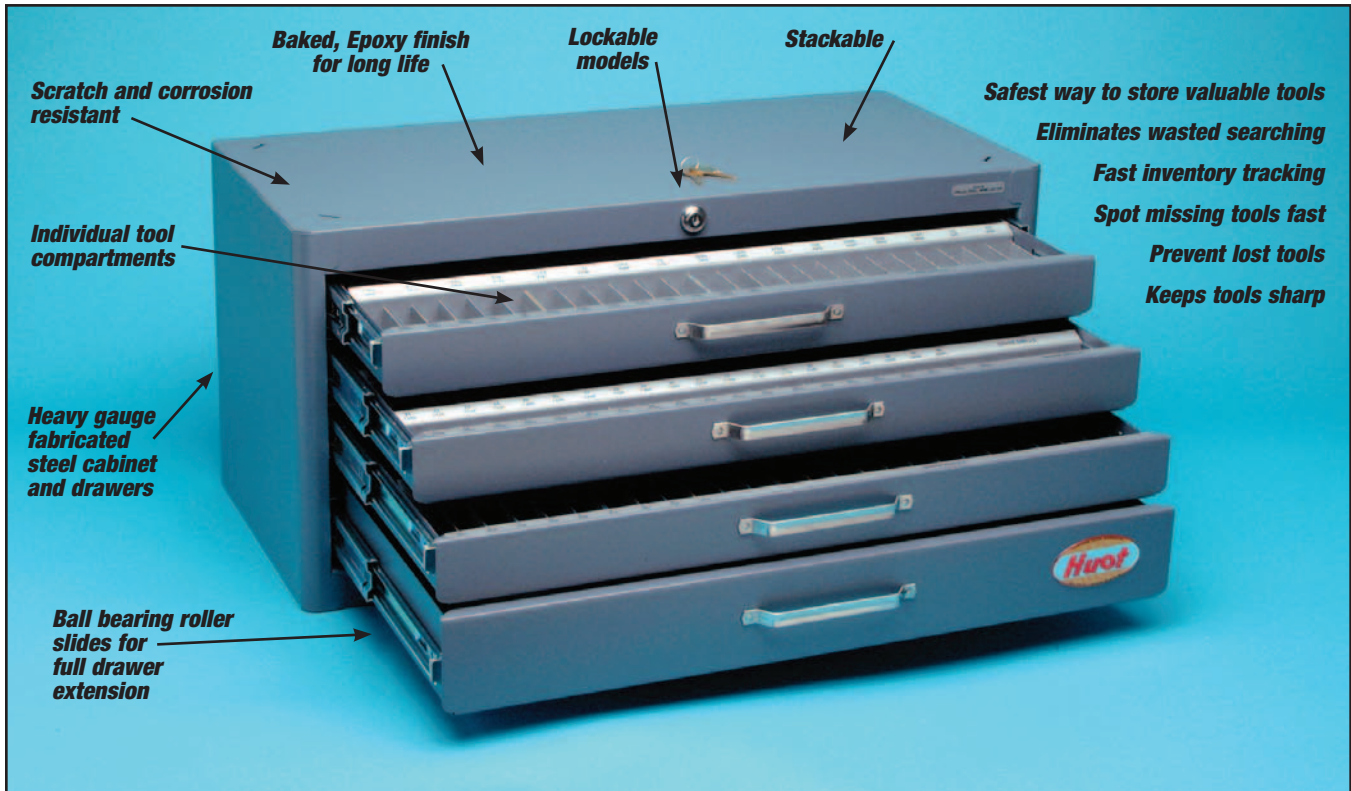

**Ball bearing slides on Master Series**



**Easy-to-read identification strips show size with decimal equivalents where applicable**



**Stackable for more efficient use of floor space**



**Custom colors available when ordering 50 or more dispensers**

## Huot Manufacturing Company

550 North Wheeler Street  
St. Paul, Minnesota 55104-1788

Phone (651) 646-1869  
Order Desk (800) 832-3838  
Fax (651) 646-0457

[www.huot.com](http://www.huot.com)  
Email: [huotmfg@huot.com](mailto:huotmfg@huot.com)

Industrial Code: 697764  
DUNS 00-614-7227  
UPC #33603  
Tax ID #41-0653132  
SIC #3469

**Distributed By:**

©2011 Huot Mfg. Co.  
Form #70511